



Handcrafted in Italy; brought to you by



guys

**UNIBLOCK ZANOTTI** mobile trailer units



King of Cold

Zanotti

14065 Townsend Road  
Philadelphia PA 19154

[www.zanottirefrigeration.com](http://www.zanottirefrigeration.com)

# UNIBLOCK AS-R

## Trailer Refrigeration Units

### Application:

The **AS** series are single block wall-mounted units that slide into the trailer or "cold room" wall. These units are suitable for the preservation of fresh products or for deep freezing.

Thanks to their robust construction, these units are capable of over-the-road or stationary operation without any additional protection from the weather.

### Features:

- (230 or 115)/1/60hz electric
- Hot Gas Defrosting
- minus 20F capability, 8 to 53' trailers
- Internal condensation eliminator
- Electronic temperature adjustment
- Slide-in installation
- Stainless steel casing
- Condenser fan pressure switches
- Fixed electrical connections
- Factory precharged with refrigerant
- 2 year warranty

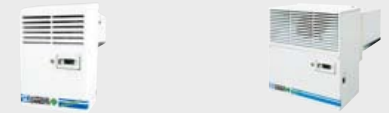

### OPTION

- Electronic fan speed adjustment
- Different supply voltage
- Power supply voltage control monitor
- Extended control panel to reach cabin
- Heating Option

### ADVANTAGES

- Over the Road use
- Precharged for fast assembly
- Plug and Play installation
- Highly Compact dimensions
- weather resistant
- Robust Compressor

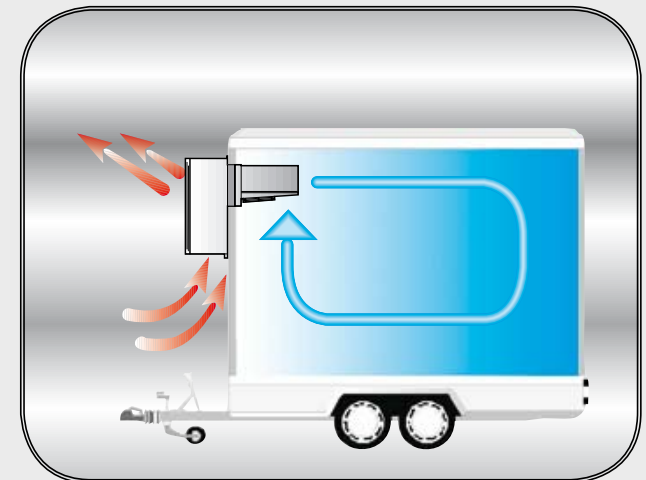



Product Code	MAS121T 443S	MAS123T 443S	MAS221N 443S	MAS221T 539F
Compressor	E	E	E	E
Nominal Power	0.46 kW	0.56 kW	0.74 kW	1.1 kW
Refrigerant	R407C	R407C	R407C	R404A
Voltage	230/1/60 or 115/1/60	230/1/60 or 115/1/60	230/1/60 or 115/1/60	230/1/60 or 115/1/60
Nominal absorption	0.6 kW 3.6 A	0.7 kW 4.2 A	1.1 kW 7.2 A	1.3 kW 8 A
Defrost	G	G	G	G
CFM cond.	412 CFM	412 CFM	825 CFM	825 CFM
CFM evap.	353 CFM	353 CFM	706 CFM	706 CFM
Air throw	14 ft	14 ft	14 ft	14 ft
Mass	115 lbs	125 lbs	170 lbs	172 lbs

Quick selection

Tc °F	Ta °F	BTU	ft³	BTU	ft³	BTU	ft³	BTU	ft³
-4	104	3456	176	4776	353	6483	675	8700	953

### AS R 121 - 123

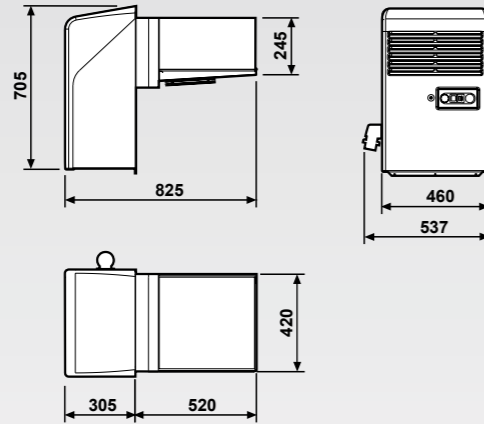

### AS R 221-135-235-335-340

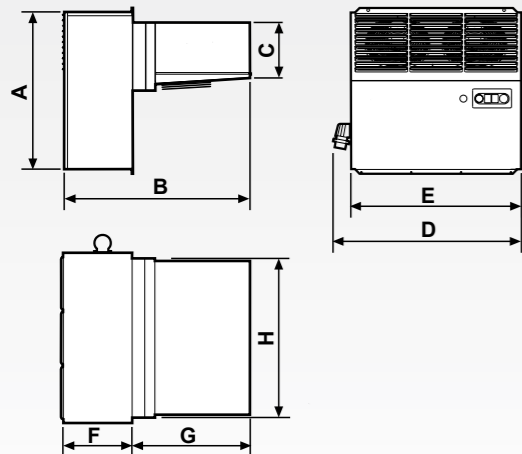

mm	A	B	C	D	E	F	G	H
AS 221	695	825	245	832	754	305	520	720
AS 135	800	1100	385	832	754	400	700	720
AS 235	857	1140	385	1329	1280	440	700	1120
AS 335	857	1410	380	1812	1750	440	970	1560
AS 340	857	1580	450	1852	1790	490	1090	1600

Product Code	MAS135 TE02F	MAS235 TE02F	MAS335 NE02F	MAS335 TE02F	MAS340 TE02F
Compressor	ES	ES	ES	ES	ES
Nominal Power	1.7 kW	2.6 kW	2.9 kW	4.4 kW	5.5 kW
Refrigerant	R404A	R404A	R404A	R404A	R404A
Voltage	230/3/60	230/3/60	230/3/60	230/3/60	230/3/60
Nominal absorption	2.2 kW 4.9 A	3.2 kW 7.3 A	4.2 kW 9.7 A	5.2 kW 11.6 A	6.9 kW 15.2 A
Defrost	G	G	G	G	G
CFM cond.	882 CFM	1590 CFM	2354 CFM	2355 CFM	3296 CFM
CFM evap.	1353 CFM	2300 CFM	3415 CFM	3413 CFM	4708 CFM
Air throw	34 ft	34 ft	34 ft	34 ft	34 ft
Mass	234 lbs	362 lbs	490 lbs	496 lbs	654 lbs

Quick selection

Tc °F	Ta °F	BTU	ft³	BTU	ft³	BTU	ft³	BTU	ft³	BTU	ft³
50	68	17,623	2649	26,635	4344	35,800	6145	44,588	7946	49,034	8864
	77	16,580	2472	25,205	4061	33,692	5721	41,939	7381	46,140	8264
	86	15,503	2260	23,716	3779	31,536	5297	39,206	6816	43,162	7628
	95	14,384	2048	22,167	3496	29,327	4873	36,384	6251	40,098	6992
	104	13,222	1836	20,549	3178	27,071	4414	33,472	5686	36,947	6357
41	68	15,943	2331	24,171	3849	32,174	5403	40,233	7028	44,089	7840
	77	14,994	2154	22,864	3602	30,248	5050	37,823	6533	41,481	7275
	86	14,010	1978	21,504	3355	28,278	4662	35,338	6039	38,797	6745
	95	12,989	1801	20,087	3108	26,264	4273	32,771	5544	36,039	6180
	104	11,927	1624	18,610	2825	24,203	3885	30,125	5015	33,195	5615
32	68	14,265	2048	21,708	3390	28,548	4697	35,878	6145	39,140	6816
	77	13,407	1872	20,527	3178	26,804	4379	33,707	5721	36,821	6357
	86	12,515	1730	19,292	2966	25,023	4026	31,470	5262	34,433	5862
	95	11,594	1554	18,010	2719	23,197	3673	29,161	4838	31,976	5368
	104	10,636	1413	16,668	2472	21,334	3320	26,776	4379	29,447	4873
23	68	12,587	1730	19,248	2931	24,922	4026	31,524	5297	34,194	5827
	77	11,817	1589	18,186	2755	23,364	3708	29,594	4909	32,162	5403
	86	11,022	1483	17,080	2543	21,768	3426	27,602	4520	30,069	5015
	95	10,199	1307	15,930	2331	20,134	3108	25,551	4132	27,917	4591
	104	9,341	1165	14,730	2119	18,462	2790	23,430	3708	25,698	4167
114	8,452	1024	13,479	1907	16,753	2472	21,243	3320	23,414	3708	



Product Code	BAS221 T442F	BAS135 TE02F	BAS235 TE02F
Compressor	ES	ES	ES
Nominal Power	1.7 kW	2.6 kW	3.7 kW
Refrigerant	R404A	R404A	R404A
Voltage	230/1/60 or 115/1/60	230/1/60 or 115/1/60	230/1/60 or 115/1/60
Nominal absorption	1.2 kW 7.7 A	2.8 kW 6.1 A	3.5 kW 7.7 A
Defrost	G	G	G
CFM cond.	825 CFM	882 CFM	1590 CFM
CFM evap.	706 CFM	1350 CFM	2295 CFM
Air throw	14 ft	34 ft	34 ft
Mass	172 lbs	256 lbs	396 lbs

Product Code	BAS335 NE02F	BAS335 TE02F	BAS340 TE02F
Compressor	ES	ES	ES
Nominal Power	4.4 kW	5.5 kW	7.4 kW
Refrigerant	R404A	R404A	R404A
Voltage	230/1/60 or 115/1/60	230/1/60 or 115/1/60	230/1/60 or 115/1/60
Nominal absorption	4.6 kW 10.5 A	6.1 kW 13.4 A	7.9 kW 17.3 A
Defrost	G	G	G
CFM cond.	2354 CFM	2354 CFM	3295 CFM
CFM evap.	3413 CFM	3413 CFM	4708 CFM
Air throw	34 ft	34 ft	55 ft
Mass	510 lbs	620 lbs	655 lbs

*Quick selection*

Tc °F	Ta °F	BTU	V100 ft³	BTU	V100 ft³	BTU	V100 ft³
5	68			12648	1660	19619	3107
	77			11864	1518	18473	2860
	86			11051	1342	17278	2613
	95			10216	1201	16033	2330
	104			9349	1024	14730	2083
-4	68			8452	883	13368	1801
	77			11147	1342	17353	2613
	86			10461	1236	16357	2436
	95	4777	388	9751	1095	15316	2189
	104			9018	989	14228	1977
-13	68			8257	847	13095	1730
	77			7469	706	11908	1518
	86			9649	1095	15088	2154
	95			9059	989	14238	1977
	104			8448	883	13351	1801
-13	95			7817	742	12427	1589
	104			7165	671	11461	1412
	114			6490	530	10451	1236

*Quick selection*

Tc °F	Ta °F	BTU	V100 ft³	BTU	V100 ft³	BTU	V100 ft³
5	68	25416	4448	28995	5332	38733	7945
	77	23846	4095	27170	4908	36239	7274
	86	22239	3707	25297	4414	33670	6568
	95	20598	3318	23379	3990	31025	5861
	104	18916	2965	21410	3531	28303	5191
-4	68	17193	2577	19390	3037	25494	4484
	77	22140	3671	25348	4449	33926	6638
	86	20782	3354	23748	4061	31755	6073
	95	19390	3036	22106	3672	29524	5508
	104	17971	2753	20424	3284	27224	4908
-13	68	16514	2436	18698	2931	24853	4343
	77	15023	2153	16927	2507	22413	3743
	86	18862	2965	21700	3566	29118	5367
	95	17715	2718	20325	3284	27276	4943
	104	16545	2436	18916	2966	25375	4449
-13	95	15344	2189	17469	2648	23420	3990
	104	14115	1942	15989	2330	21407	3531
	114	12856	1694	14467	2013	19332	3037

Inject silicone seal round the whole perimeter

Packing mass and dimensions

**AS R 121 - 123**

**AS R 221-135-235-335-340**

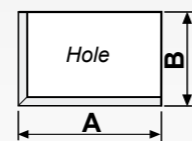
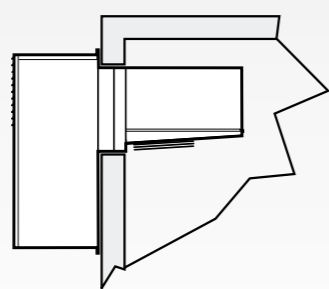
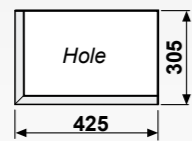
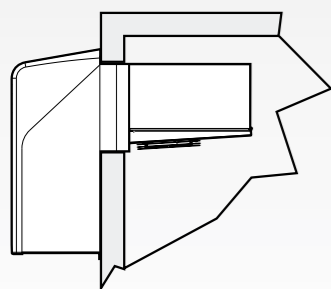

mm	A	B
AS 221	725	305
AS 135	725	475
AS 235	1130	480
AS 335	1600	510
AS 340	1640	580

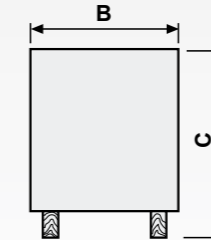
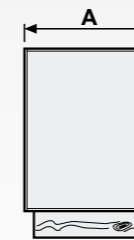

mm	A	B	C	lbs	Vol (ft)
AS 121-R	569	874	907	35	16
AS 123-R	569	874	907	35	16
AS 221-R	869	874	907	48	25
AS 135-R	1014	1134	1029	68	42
AS 235-R	1384	1204	1107	97	42
AS 335-R	1280	1940	1100	260	96
AS 340-R	1400	1980	1100	282	107

# King of Cold



Zanotti

14065 Townsend Road  
Philadelphia PA 19154

[www.zanottirefrigeration.com](http://www.zanottirefrigeration.com)